

6

5

4

3

2

1

MATERIAL AND FINISH:

Insulator: Impact resistance Polypropylene, black, UL-94V-HB rated

PDSN-20A (wire leads): PVC, 26 AWG

Contact & terminals:

PDSN-20B: Brass, Nickel plated

PDSN-20C: Brass, Nickel plated

Spring: Spring Steel, Nickel plated imbedded in Polypropylene

ENVIRONMENTAL:

Operating temperature: -5°C to +83°C

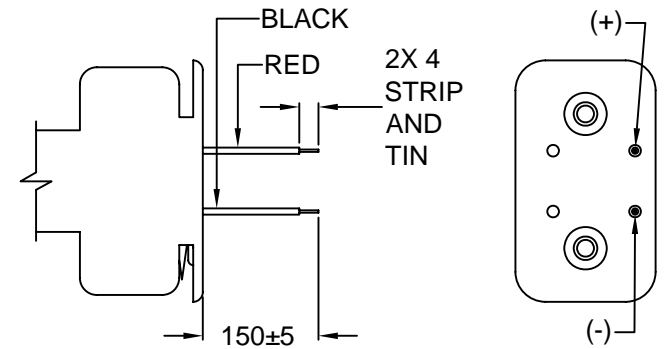

PDSN-20A WIRE LEADS

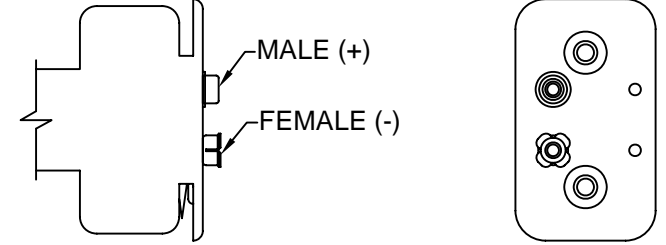

PDSN-20B SNAP TERMINAL

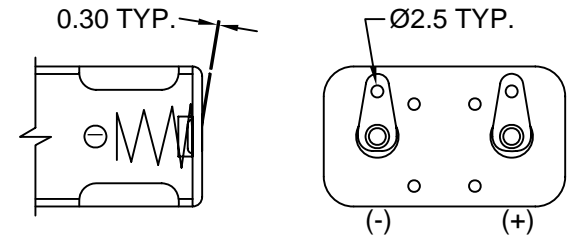

PDSN-20C SOLDER LUGS

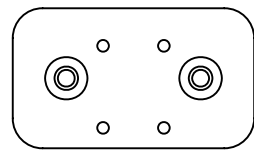
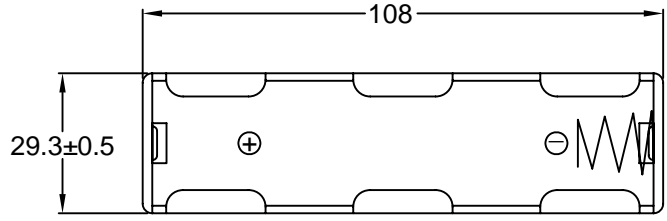
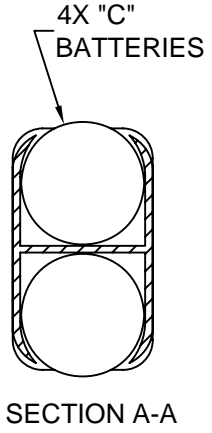
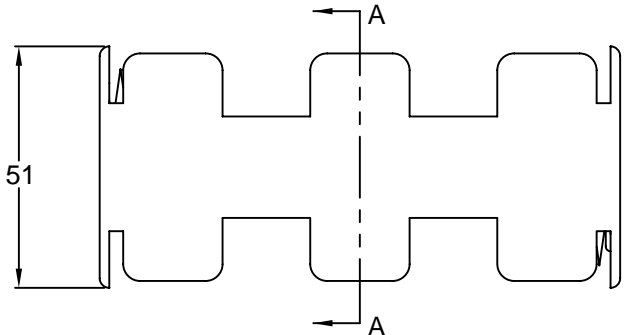

TOLERANCE UNLESS OTHERWISE SPECIFIED

X	± 1
X.X	± 0.4
X.XX	± 0.20

Power Dynamics, Inc.
Phone: 973 560-0019 Whippany, New Jersey Fax: 973 560-0076

PART: 4 CELL TYPE "C" BATTERY HOLDER
SIDE BY SIDE

DRAWN BY	GQ	DATE:	05/10/02
CHECK BY	TD	DATE:	05/14/02
APPR BY	PB	DATE:	05/14/02

PART #: **PDSN-20X**
SIZE: A
SCALE: NTS
ALL DIMENSIONS FOR REFERENCE ONLY
DIMENSIONS ARE IN MILLIMETERS

SHEET 1 of 1
REV:

D

C

B

A

REV	DATE	CHANGE	CHKG	CHKD	APPR

6

5

4

3

2

1